



**HATSAN**  
ARMS COMPANY

**ESCORT**  
Semi Automatic Shotgun



**SMART**  
VALVE PISTON

**FAST**  
LOADING SYSTEM

# Instruction Manual

Read this manual before using your shotgun

# CONTENTS

	Page
SAFETY MEASURES _____	3
NOMENCLATURE _____	4
PARTS LIST _____	5
EXPLODED VIEW _____	6
TECHNICAL FEATURES and DATA _____	8
EXTERNAL CONTROL PARTS _____	8
ASSEMBLY INSTRUCTIONS _____	9
LOADING THE SHOTGUN _____	10
USE OF THE “MAGAZINE CUT-OFF BUTTON” _____	10
USE OF THE “MAGAZINE EXTENSION” _____	11
USE OF THE “MIGRATORY MAGAZINE PLUG” _____	12
FIRING THE SHOTGUN _____	12
USE OF THE “CHOKES” _____	13
UNLOADING _____	15
DISASSEMBLY INSTRUCTIONS _____	16
USE OF THE “STOCK DROP SPACERS” _____	16
CARE, CLEANING AND LUBRICATION _____	17
ILLUSTRATIONS _____	18

Congratulations and thank you for choosing Hatsan ESCORT semi automatic shotgun.

### **WARNING!**

**Read very carefully this instruction manual before handling this shotgun. Incorrect handling may result in serious injury or death to you or bystanders.**

Always keep this manual with your shotgun. Make sure you understand all the operation instructions, safety procedures and warnings in this manual before you handle the shotgun.

If you sell, lend or give the shotgun to another, make sure this manual goes with it.

### **WARNING!**

**Always keep your finger outside the trigger guard and be sure that the safety is fully engaged until you are ready to fire. The safety is fully engaged only when its red ring is completely covered and it can be moved no further toward the “on” position.**

## **SAFETY MEASURES**

- Always point the shotgun in a safe direction even though it may be unloaded. Do not point the shotgun at anything you do not intend to shoot. Avoid all horseplay while handling a shotgun.
- Keep your finger away from the trigger when operating any other part of the shotgun’s mechanism.
- Keep the safety “ON” until you are actually ready to fire. Treat every shotgun with respect and caution.
- Keep your fingers away from the muzzle. Never pull a shotgun toward you by the muzzle.
- Be sure the barrel is clear of obstructions.
- Keep your shotgun unloaded when not in use and never load your shotgun if you will not shoot.
- Always aim at a safe target, taking care that it does not conceal any other object. Be sure of your target and what lies beyond before you pull the trigger. Never shoot at sounds. To avoid ricochets, do not shoot at a flat or hard surface or at water.
- Store shotguns and ammunition separately, beyond the reach of children, better if under lock and key. Shotguns should always be unloaded when stored.
- Never carry a loaded shotgun inside a vehicle, house, camp, or public place. When transporting the shotgun keep the shotgun “on safe” and unloaded. Never climb a tree or fence, or jump a ditch with a loaded shotgun.
- Never rely on any one’s words that the shotgun is “on safe” or unloaded. Always check to see if the shotgun is “on safe” and unloaded when getting it from another person or storage.
- Avoid alcoholic beverages or drugs before or during shooting.
- Always use eye & hearing protection and make sure bystanders are similarly protected.
- Although the shotgun itself does not contain any lead, it fires ammunition containing lead or lead compounds, which are known to be dangerous for health. When shooting or cleaning shotguns, take protective health measures. Avoid exposure to the lead while handling and wash your hands after contact. Proper air ventilation is absolutely necessary when shooting indoors.
- Any damage, malfunction, injury, or death resulting from the use of faulty, incorrect, non-standard, remanufactured, hand loaded or reloaded ammunition is the sole responsibility of the user.
- The user is solely responsible for the damage, injuries or death resulting from carelessness or misuse of the shotgun.

# NOMENCLATURE

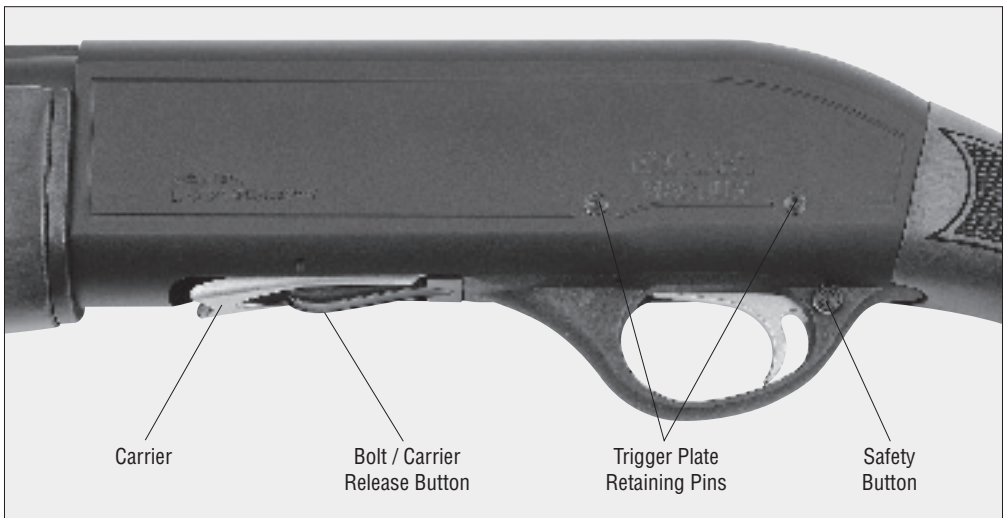
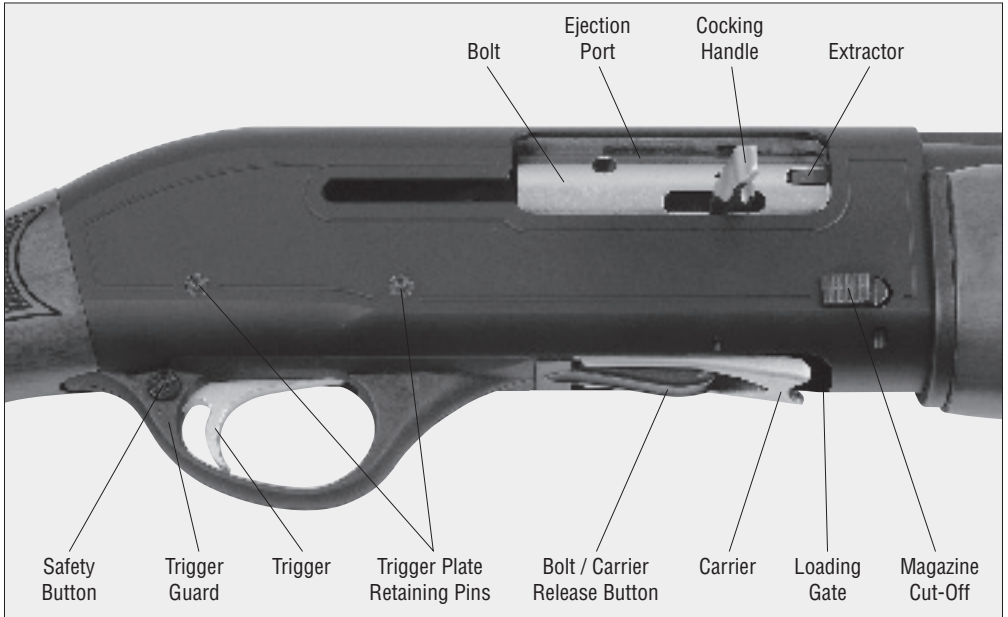
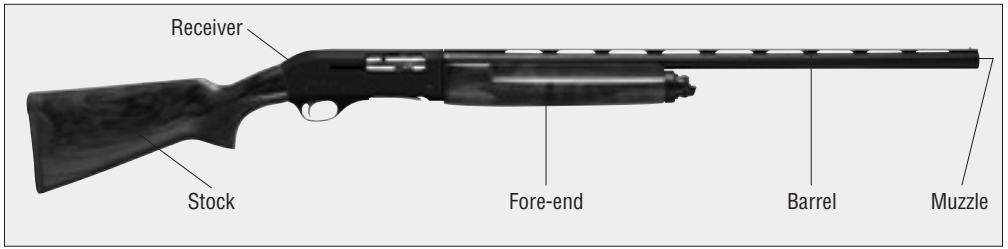

# PARTS LIST

<b>Code</b>	<b>Part's Name</b>	<b>Code</b>	<b>Part's Name</b>
101	Receiver	407	Magazine Extension Tube
102	Carrier Latch- Inner	411	Swivel Pin
103	Carrier Latch Rivet	415	Casted Swivel
104	Carrier Latch Spring	416	Gas Cylinder O-Ring
105	Carrier Latch Pin	601	Bolt
106	Shell Latch Retaining Plug	602	Locking Block
107	Shell Latch	603	Firing Pin
108	Shell Latch Spring	604	Firing Pin Spring
109	Stock Connection Plug	605	Firing Pin Stop
110	Magazine Cut-Off	606	Extractor
111	Magazine Cut-Off Spring	607	Extractor Pin
112	Magazine Cut-Off Pin	608	Extractor Spring
114	Carrier Latch -Outer	609	Extractor Retaining Pin
201	Trigger Plate	701	Stock
202	Carrier	702	Stock Connection Rod
203	Carrier Level	703	Stock Connection Rod Nut
204	Carrier Level Rivet	704	Stock Connection Rod Spring Washer
205	Carrier Spring	705	Stock Connection Rod Washer
206	Carrier Spring Guide	706	Stock Swivel Screw
207	Carrier Pin	707	Butt-Plate
208	Carrier Pin Retaining Plug	708	Butt-Plate Screws
209	Hammer	709	Stock Plastic Cap
210	Hammer Pin	710	Stock Plastic Cap Screw
211	Hammer Spring Guide	711	Stock Drop Spacer
212	Hammer Spring	718	Plastic Fore-End
213	Trigger	721	Fore-End Plate
214	Sear	722	Fore-End Plate Screws
215	Sear Spring Guide	723	Fore-End Bushing
216	Sear Spring	724	Fore-End Bushing Bearing Pin
217	Sear Pin	725	Fore-End Bushing Retaining Plug
218	Trigger Spring	726	Fore-End Bushing Bearing
219	Safety Button	727	Fore-End Bushing Bearing Spring
220	Safety Spring Guide	733	Fore-End O-Ring
221	Safety Spring	802	Action Bar Spring
222	Safety Pin	803	Action Bar Pin
223	Trigger Assembly Pins (2)	804	Action Bar Bearing Pin
226	Inner-Carrier	807	Recoil Spring
227	Inner-Carrier Spring	808	Cocking Handle
301	Slug Barrel	809	Action Bar Bearing
302	Barrel Tang	810	Action Bar Bearing Spring
303	Barrel Tang Pin	811	Action Bar
304	Ventilated Rib	812	Action Bar Bushing
306	Casted Front St	901	Stock (Complete)
308	Metal Bead Front Sight	902	Triger Group(Complete)
309	Inner Choke	903	Bolt(Complete)
311	Gas Cylinder	905	Fore-End Cap(Complete)
401	Magazine Tube	906	Ventilated Rib Barrel
402	Magazine Spring	907	Fore-End (Complete)
403	Magazine Spring Retaining Plug	908	Piston (Complete)
404	Magazine Spring Follower	909	Stock Swivel (Complete)
405	Magazine Plug	910	Action Bar (Complete)

\*\* Please specify model name, caliber and barrel length when ordering parts.

# EXPLODED VIEW

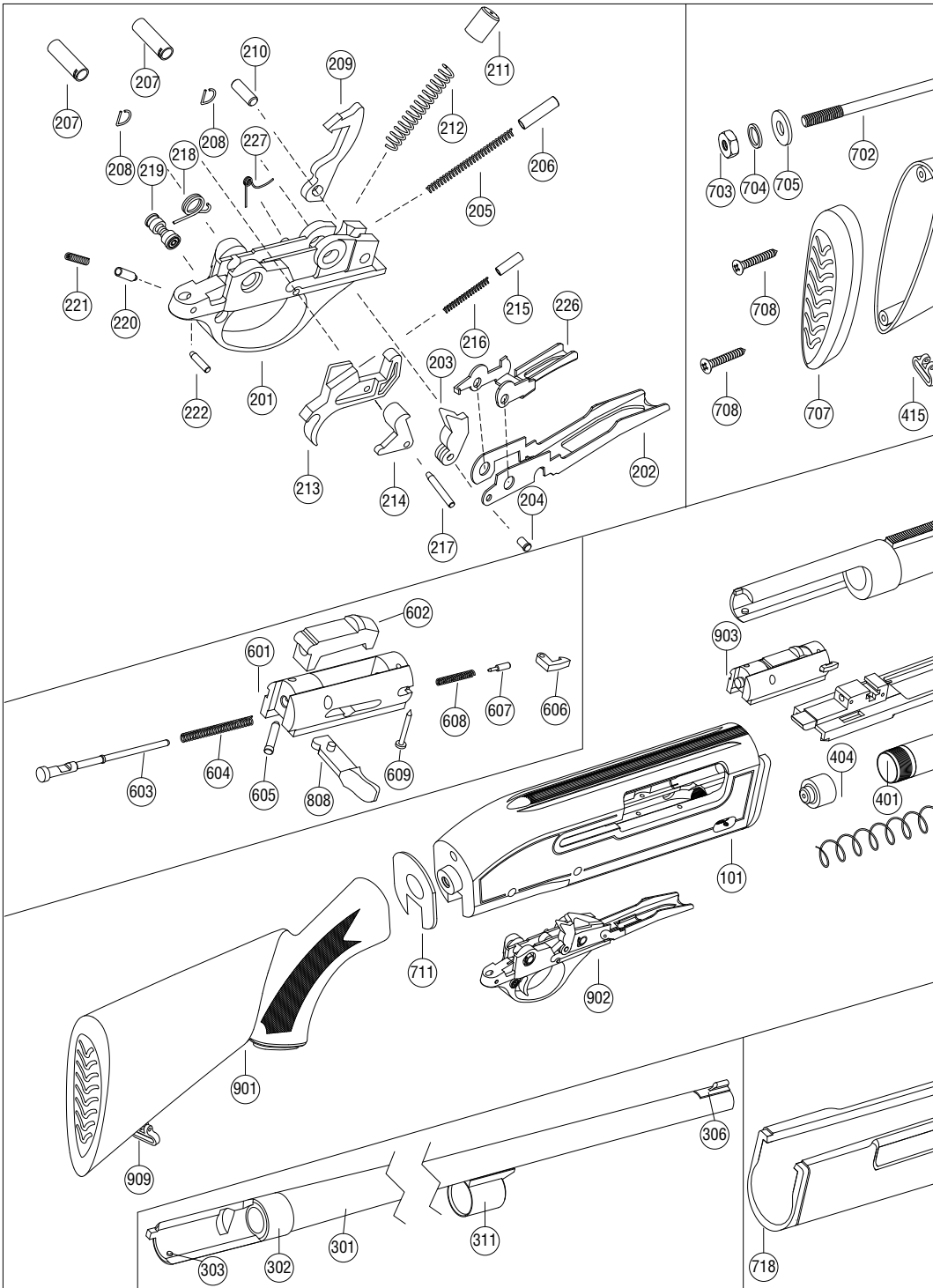



# TECHNICAL FEATURES AND DATA

Fill in below according to your shotgun:

<u>Model</u>	<u>Serial No</u>	<u>Barrel Length</u>	<u>Chamber</u>	<u>Caliber</u>	<u>Type</u>
.....	.....	.....	.....	.....	S/A shotgun

- Alternatives in barrel length;
  - 18" (46 cm)
  - 20" (51 cm)
  - 22" (55 cm)
  - 24" (61 cm)
  - 26" (66 cm)
  - 28" (71 cm)
  - 30" (76 cm)
- Synthetic stocks are made from advanced polymer compounds, wooden stocks are made from kiln dried and moisture stabilized Turkish walnut.

## EXTERNAL CONTROL PARTS

("Right" and "Left" refer to the shotgun as seen by a shooter holding it in the firing position.)

### Cross Button Safety:

It is located behind the trigger on the trigger housing.

When the red ring on its left side is visible, it means that the cross button safety is disengaged ("OFF") and shotgun is ready to fire. **(1)**

To engage the cross button safety, push it fully to the right until its red ring disappears and it will move no further. The safety is now **ON**, blocking the trigger from being pulled. **(2)**

To take the safety "**OFF**", push the button fully to the left, exposing its red ring. The trigger can now be pulled.

### WARNING!

- 1. Always keep the cross button safety "ON" until you are ready to fire and the muzzle is pointing at the target.**
- 2. Make sure that you understand how all controls work before you attempt to load the shotgun.**
- 3. Keep the muzzle pointed in a safe direction and your finger off the trigger when operating the safety. Malfunctions which may cause a shotgun to fire is engaged or disengaged are rare but can happen. Even if an accidental firing should occur, nobody will be hurt if you follow this rule.**

### THREE THINGS TO REMEMBER ABOUT SAFETIES

- 1. NEVER TOTALLY DEPEND ON A MECHANICAL SAFETY.** It is not a substitute for proper shotgun handling. Like all mechanical devices the safety is subject to breakage or malfunction and can be defeated by wear, abuse, dirt, corrosion, incorrect assembly of the shotgun, improper adjustment or repair, or lack of maintenance.
- 2. NO MECHANICAL SAFETY IS "CHILDPROOF" OR "FOOLPROOF".** No safety ever invented can be relied upon to prevent an accidental shooting by a determined child or a grownup idiot "playing" with a shotgun.
- 3. TREAT EVERY SHOTGUN AS IF YOU EXPECT ITS MECHANICAL SAFETY NOT TO WORK.** You will be astounded at how cautious you become, and how little tolerance you will have for the complacency of others.



**Carrier:**

It is located under the receiver, in front of the trigger guard.

**Bolt / Carrier Release Button (Fast Loading System):**

It is located on the carrier.

When the bolt is locked open, depressing this button releases the bolt and carrier.

It enables fast & easy loading of shot shells into the magazine tube.

**Trigger:**

It is located in the trigger guard. With the safety “OFF” and a cartridge in the chamber, pulling the trigger fires the shotgun.

**Bolt Cocking Handle:**

It is located at the right side of the shotgun, protruding from the bolt. It is used for retracting the bolt.(3)

**Fore-end Cap:**

It is located at the end of the magazine tube, in front of the fore-end and under the barrel. It is screwed (clock-wise) on the magazine tube to keep the fore-end and barrel properly in their place.

## ASSEMBLY INSTRUCTIONS

Your new semi auto shotgun is packed dismounted in its box, i.e. barrel is separated from the stock-receiver-fore-end assembly. To attach the barrel, first remove all parts from the nylon bags. Before proceeding with the assembly of the shotgun, carefully check the “Nomenclature” and read “Safety Measures” sections.

**WARNING!**

**Before assembling the barrel, check the barrel. Bore and cartridge chamber must be clean and there should be no obstructions in them. Look through the loading gate and assure that magazine tube and receiver are empty.**

- Assemble the barrel as follows:
- Unscrew (counter-clockwise) the fore-end cap. (4)
- Remove the fore-end from the magazine tube. (5)
- Be sure that the rubber “O” ring is in place and in good condition. (6)
- Insert the barrel extension into the receiver. While doing this be sure that the gas port ring is aligned with the magazine tube and the barrel extension seats between the bolt and the receiver. Continue to slide the barrel extension into the receiver; here gas port ring would slide over the magazine tube. Retract the bolt backwards by means of bolt cocking handle until it is locked at the rear. Then completely insert the barrel extension into the receiver. (7)
- Slide the fore-end over the magazine tube until it completely seats around the barrel-receiver magazine tube assembly and until fore-end cap threaded post protrudes. (8)
- Screw (clock-wise) the fore-end cap until it is tight and the fore-end is held firmly in place. (9)
- Check that the fore-end, barrel and fore-end cap are securely in place. Keeping fingers away from the ejection port and the path of the bolt cocking handle, depress the bolt/carrier release button so that the bolt snaps closed and locks into the barrel extension. (10)
- Depress the trigger to lower the hammer.

## **WARNING!**

- IF
  1. Bolt does not slide forward
  2. There is a gap between the fore-end and receiver
  3. Barrel extension protrudes from the receiver

that means you have not assembled the shotgun properly. In such a case, immediately reverse assembly procedures and re-assemble your shotgun making sure that the barrel is completely inserted into the receiver, fore-end is completely in place and there are no gaps. If you still cannot assemble the shotgun properly take it to a qualified shotgunsmith for help.

**\*\*After you assembled your shotgun or if you are taking it to a gunsmith for help, make sure that you keep the safety "ON".**

## **LOADING THE SHOTGUN**

### **WARNING!**

- Always keep your fingers away from the trigger if you do not intend to fire.
- Always check cartridge chamber, magazine tube and receiver to see that the shotgun is not already loaded.
- While you load the shotgun, always point the barrel in a safe direction.
- Always use the correct ammo size, which your shotgun is chambered.
- Always keep the safety "ON" while loading your shotgun.

### **Load the shotgun as follows:**

- Point the muzzle in a safe direction!
- Put the safety "ON" if it is disengaged.
- Retract the bolt by means of cocking handle until it is locked at the rear. **(3)**
- Insert through the ejection port the first round into the cartridge chamber. **(11)**
- Keeping fingers away from the ejection port and the path of the bolt cocking handle depress the bolt/carrier release button, so the bolt snaps closed and is locked at the front. **(10)**
- Turn the shotgun upside down so that the carrier is facing up. By depressing the bolt/carrier release button with the shot shells, insert up to 4 cartridges (if the magazine extension assembled up to 7 cartridges and if the magazine plug assembled up to 2) into the magazine tube until the last cartridge engages the stop tooth. **(12)**

### **WARNING!**

**Shotgun is now loaded and ready to be fired.**

### **USE OF THE "MAGAZINE CUT-OFF BUTTON"**

When engaged the magazine cut-off button prevents the feeding of any cartridges from the magazine tube into the chamber. This offers the possibility to extract the live round from the cartridge chamber and lock the bolt open for safety reasons, or to replace the round in the cartridge chamber with a different load.

### **WARNING!**

**The magazine cut-off is not a safety! Whenever a cartridge is in the chamber and the safety is "OFF" the shotgun is ready to fire. Keep the safety "ON" even when using the magazine cut-off button, until you are ready to shoot.**

**NOTE: Magazine cut-off button disengages automatically after the shot. That is; it is good for one shot only.**

**Therefore it should be hold pressed while shooting or should be pressed again after the shot to operate the magazine cut-off button again.**

### **Use the magazine cut-off button as follows:**

- At all times keep the muzzle pointed in a safe direction!
- Engage the magazine cut-off button by depressing it. **(13)**
- Retract the bolt by means of cocking handle to extract the live round from the cartridge chamber and to eject it through the ejection port. **(14)**

By this operation you can notice that the bolt locks at the rear and the carrier is locked by the magazine cut-off button, i.e. feeding from the magazine tube is blocked.

- When you intend to fire, insert the extracted cartridge or another one of choice into the cartridge chamber. Keeping fingers away from the ejection port and the path of the bolt cocking handle, depress the bolt/carrier release button to close the bolt **(10)** Or, again keeping fingers away from the ejection port and the path of the bolt cocking handle, simply disengage the magazine cut-off button, so the next round from the magazine tube will be fed into the cartridge chamber.

### **USE OF THE “MAGAZINE EXTENSION”**

Magazine extension when assembled increases the capacity of the shotgun from 4+1 to 7+1.

PS. Magazine extension is optional. Consult your dealer about your country's laws regarding the use.

**It is recommended to have your magazine extension assembled by a qualified gunsmith.**

### **WARNING!**

**Make sure that the shotgun is unloaded and the safety “ON” before assembling the magazine extension.**

### **Assemble the magazine extension as follows:**

- Engage safety and make sure that the shotgun is unloaded, if it is loaded unload it (see Unloading section).
- Unscrew (counter-clockwise) the fore-end cap. **(4)**
- With a snipe nose or hawknosed pliers, start extracting the magazine spring retaining plug very slowly. While doing this, press and control the magazine spring retaining plug with your other hand to prevent the magazine spring flying out of the magazine tube with very high impact and velocity which may be very dangerous. **(15)**

### **WARNING!**

**Removing or replacing the magazine spring, its retaining plug, the magazine extension or the magazine plug can be dangerous if done carelessly. These parts are under heavy spring tension and can fly out of the magazine tube with high velocity and considerable force if not properly restrained. Therefore be extremely careful when performing these operations. Wear protective glasses. Keep a firm grip on the parts as they are being assembled or disassembled. Point the shotgun in a safe direction so that no one can be struck if any of these parts is accidentally released.**

- After removal of the magazine spring retaining plug, place the magazine spring inside the magazine tube and put the magazine extension over the magazine spring.
- With your fingers compress the magazine spring into the magazine tube, meanwhile with your other hand press the magazine extension downwards very slowly and tightly. **(16)**
- Compress the magazine spring by means of magazine extension until the magazine extension can be screwed on the threaded part at the end of the magazine tube. Then screw (clock-wise) the magazine extension until it seats completely on the magazine tube, i.e. magazine tube would do the duty of the fore-end cap. **(17)**

Now the capacity of the shotgun is increased to 7+1 (7 cartridges in the magazine tube and 1 cartridge in the cartridge chamber).

**NOTE:** To disassemble the magazine extension, reverse assembly of it by being extremely careful while unscrewing (counter-clockwise) the magazine extension to remove the magazine spring from the magazine tube, since they may fly out with high impact and velocity.

### **USE OF THE “MIGRATORY MAGAZINE PLUG”**

Migratory magazine plug when assembled decreases the capacity of the shotgun to 2+1 for safety reasons or for the regulations varying from country to country.

PS. Migratory magazine plug is optional. Consult your dealer about your country’s laws regarding use of this.

**It is recommended to have your migratory magazine plug assembled by a qualified gunsmith.**

**NOTE:** Follow the warning in the “use of the magazine extension” section for the migratory magazine plug as well

Assemble the migratory magazine plug as follows:

- Follow the first three steps and all the warnings in the “assembly of the magazine extension” section.
- Keeping the flat end of the migratory magazine plug at the top, insert it inside the magazine spring. **(18)**
- Place the magazine spring retaining plug on the magazine spring and migratory magazine plug assembly. Then, with your fingers, compress the spring into the magazine tube very carefully, meanwhile, with your other hand press the magazine spring retaining plug downwards very slowly and tightly until it completely seats in its place and holds the magazine spring by itself. **(19)**
- Place the fore-end washer on the fore-end (for wood stocks only) and screw (clockwise) the fore-end cap until it is completely in its place. **(9)**

Now the capacity of the shotgun is reduced to 2+1 (2 cartridges in the magazine tube and 1 in the cartridge chamber).

**NOTE:** To disassemble the migratory magazine plug, reverse assembly procedure of it.

## **FIRING THE SHOTGUN**

### **WARNING!**

- **When firing, keep your fingers and other objects away from the path of the bolt and the bolt cocking handle since they move backward and forward with considerable force and velocity.**
- **Keep the safety “ON” and your finger outside the trigger guard until you are actually ready to fire and aimed at your intended target.**
- **Bolt will remain open (locked to the rear) after the last round is fired, but never rely on this. Always check with your eyes to verify no cartridge is left in the chamber and magazine.**
- **Your semi auto shotgun, like other semi auto shotguns, feed the next round from the magazine tube into the cartridge chamber each time you fire. Since no mechanical force is necessary to fire another round after the previous one is ejected, always be aware that the shotgun is ready to fire as long as it is loaded.**

**Fire with your shotgun as follows;**

- Wear eye and ear protection.
- Engage safety and load your shotgun. (see Loading section)
- Point the barrel at your intended target.
- Disengage safety and take aim.
- Press the trigger.

It is not uncommon while loading or firing any semi-automatic shotgun to experience a malfunction in which an unfired cartridge or fired cartridge case becomes jammed between the bolt and the barrel. Clear such a stoppage as follows. Point the muzzle in a safe direction. Put the safety "ON". If possible, engage the magazine cut-off to prevent the next cartridge in the magazine from being released and adding to the jam. Pull back the bolt and hold or lock it to the rear. The jammed cartridge or case can then be removed by shaking it out, or picking it out with your fingers.

### **WARNING!**

- **If the trigger is pulled and a "click" is heard but a chambered cartridge fails to fire, follow the below instructions.**
  1. **Point the shotgun in a safe direction.**
  2. **Engage safety and the magazine cut-off.**
  3. **Wait 30 seconds.**
  4. **Eject the cartridge from the chamber by retracting the bolt. Examine the cartridge primer. If it has been deeply indented by the firing pin, the cartridge is defective. If it has been indented lightly or not at all, rechamber the cartridge and try again.**
  5. **If still it does not fire unload the shotgun and take it to a qualified gunsmith.**
- **When you are firing, if you notice that the sound of any cartridge is considerably louder or softer than the previous one, stop firing and do not load the shotgun anymore. In such a case, follow the below instructions.**
  1. **Point the shotgun in a safe direction.**
  2. **Engage safety.**
  3. **Follow the instructions in the "unloading section" and unload the shotgun completely.**
  4. **With the shotgun unloaded, check the barrel for blockage or damage, and inspect the mechanical portions and receiver of the shotgun for damage. If you notice any damage or malfunction in the shotgun take it to qualified gunsmith.**

### **USE OF THE "CHOKES"**

Shotgun choke is a constriction in the end of a shotgun barrel which focuses the shot into a tighter stream--much like a nozzle on the end of a water hose, which does exactly the same thing for exactly the same reason.

There are three different choke-system:

1. Screw-in (Inner) Chokes.
2. Extension Chokes.
3. Fixed Cylinder Bore Choke.

Choice of the chokes depends on the barrel length.

<b>Choke</b>	<b>Barrel Length (inches / centimeters)</b>				
Screw-in	22 / 55	24 / 61	26 / 66	28 / 71	30 / 76
Extension	20 / 51 (*)	22 / 55	24 / 61		
Fixed Cylinder Bore	18 / 46 (*)	20 / 51 (*)			

(\*) 18"/46 and 20"/51 cm barrel semi automatic shotguns are being produced with fixed cylinder bore choke system as standard.

### **WARNING!**

**Use the choke type that is suitable to your shotgun's barrel length**

## 1. Screw-in (Inner) Chokes:

There are 5 different screw-in (inner) chokes that can be used on your shotgun. **(20)**

- F (Full / )
- IM (Improved Modified /// )
- M (Modified /// )
- IC (Improved Cylinder //// )
- Cyl-Skeet (Cylinder-Skeet ///// )

Your shotgun is packed with either 3-choke system or 5-choke system. If your shotgun has the screw-in choke configuration.

Most common and preferred 3-choke system is F, M, IC chokes. However different combination 3-choke systems are possible depending on the conditions of different countries.

5-choke system contains all the inner chokes being F, IM, M, IC, Cyl-Skeet.

Check the number and markings on the chokes to find out the inner choke configuration of your shotgun.

All screw-in (inner) chokes have one, two, three, four or five notches, which indicate the type of the screw-in choke, i.e. F choke has one, IM has two, M has three, IC has four and Cyl-Skeet has five notches. Please also check the markings on chokes.

**Note:** M, IC and Cyl-Skeet choke tubes are good for steel shot. F, IM Choke tubes are lead shot only!

Choke	Constriction (12 Gauge)	Pattern Percentage
Cylinder-Skeet	0-0.005" (0-0.12 mm)	40% - 53%
Improved Cylinder	0.010" (0.25 mm)	57%
Modified	0.020" (0.50 mm)	67%
Improved Modified	0.030" (0.75 mm)	73%
Full	0.040" (1.0 mm)	75%

Above table shows the constriction & pattern percentage versus inner chokes. Pattern percentages are taken at a distance of 36.5 meters (40 yards). The number of pellets striking within a 76 mm (30 inch) circle, drawn so as to encompass as many pellet holes as possible, is counted and compared with the number of pellets contained in an identical unfired shell. The result is expressed as a percentage. As can be seen from above table Full inner choke has the most accuracy and accuracy decreases from Full to Cyl-Skeet inner choke which has the least accuracy. Expansion of the shot pellets within a distance is the least in Full inner choke and it is the most in Cylinder-Skeet inner choke.

### Turkey Hunting Choke Tube (Extra Full Choke)

Extra full choke tubes are also available which are specially designed for turkey hunting.

**NOTE:** Extra full choke tubes are for lead shot only

### **WARNING!**

- **Make sure the shotgun is unloaded and the safety "ON" before you assemble/disassemble the chokes.**
- **Under safety conditions (cartridge chamber empty, receiver empty, magazine tube empty, safety engaged), check whether the choke worked loose during use. In such a case, the choke must be tightened to the end by means of the choke wrench.**

### Assembly & disassembly of the inner chokes:

- Take one of the inner chokes of your choice. Place it inside barrel and by means of choke wrench; screw (clockwise) it to the end until it is completely tightened. **(21)**
- To disassemble, unscrew (counter-clockwise) by means of choke wrench and remove it.

## 2. Extension Chokes:

There are 3 different extension chokes. **(22)**

- F (Full )
- IM (Improved Modified )
- M (Modified)

Your shotgun is packed with F, IM, M extension chokes if your shotgun has the extension choke configuration.

Full extension choke is the longest in length and Modified extension choke is the shortest one in length.

Check below table regarding constriction and pattern percentage of extension chokes

Choke	Constriction (12 Gauge)	Pattern Percentage
Modified	0.020" (0.50 mm)	67%
Improved Modified	0.030" (0.75 mm)	73%
Full	0.040" (1.0 mm)	75%

As can be seen from above table Full extension choke has the most accuracy and accuracy decreases from Full to Modified extension choke which has the least accuracy. Expansion of the shot pellets within a distance is the least in Full extension choke and it is the most in Modified extension choke.

**NOTE:** Extension chokes are for lead shot only!

### Assembly & disassembly of the extension chokes:

**NOTE:** Follow the warnings in the screw-in (inner) chokes section for the extension chokes as well.

- Take one of the extension chokes of your choice. Place it inside barrel and by means of the choke wrench; screw (clockwise) it to the end until it is completely tightened. **(23)**
- To disassemble, unscrew (counter-clockwise) by means of choke wrench and remove it.

## 3. Fixed Cylinder Bore Choke

Fixed Cylinder Bore Choke means the choke constriction is pre-machined into the barrel at the factory. No choke adjustments can be made and no interchangeable chokes can be put.

18" (46 cm) and 20" (51 cm) barrel semi autos are produced with this choke system as standard.

# UNLOADING

### **WARNING!**

**Keep your fingers off the trigger and keep the safety "ON".**

#### **Unload your shotgun as follows;**

- Point the shotgun in a safe direction and engage the safety. **(2)**
- Engage the magazine cut-off button and retract the bolt by means of cocking handle, and eject the live round. **(13) & (14)**
- Keeping fingers away from the ejection port and the path of the bolt cocking handle, depress the bolt/carrier release button to lock the bolt at the front. **(10)**
- Disengage magazine cut-off button.
- Depress the bolt (carrier release) button and press the carrier inward. **(24)**

At this position slowly retract the bolt by means cocking handle, to the point **(shown in 25)** where carrier stays at the bottom by itself. Then take your fingers away from the carrier button and loading gate. Pull the bolt fully to the rear by means of bolt cocking handle to eject the cartridge in the magazine tube. **(26)**

Repeat this process until no more rounds are ejected from the magazine tube.

- When no more rounds are ejected from the magazine tube, visually check to assure the magazine

- tube and receiver are empty, and retract the bolt enough to see and make sure that the cartridge chamber is empty.
- Disengage safety and pointing the shotgun in safe direction (even though it may be unloaded), depress the trigger to lower the hammer.

## DISASSEMBLY INSTRUCTIONS

### **WARNING!**

**Before disassembling the shotgun, always make sure that the shotgun is not loaded, barrel is pointed in a safe direction and safety “ON”.**

#### **Disassemble the shotgun as follows:**

- With the bolt in the forward position unscrew (counter-clockwise) the fore-end cap. Remove the fore-end cap from the magazine tube. **(4)**
- Grasp the barrel and remove it from the stock-receiver-magazine tube assembly. **(27)**
- With your fingers compress the bolt to align the two notches on the bolt where the cocking handle is attached. Then with your other hand pull the bolt cocking handle and remove it from the bolt. **(28)**  
\*\* Bolt cocking handle is secret coded to prevent falling risk of it.
- Remove the rubber ‘O’ ring and gas piston out of the magazine tube by sliding them. **(29)**
- Slide the bolt and the action bar forwards and remove them from the magazine tube-receiver assembly. While doing this be careful since the bolt may fall from the action bar. Therefore keep the bolt up during this operation. **(30)**
- To remove the trigger assembly, first punch the two pins out with a hammer. **(31)**  
Press the carrier downwards until the trigger assembly moves downwards and then pull the trigger assembly downwards by means of trigger guard to remove it completely. **(32)**  
\*\* Trigger assembly also can be removed without first removing either barrel or bolt assembly.

**NOTE:** To reassemble the shotgun, reverse the above disassembly procedures.

#### **USE OF THE “STOCK DROP SPACERS”**

Stock drop spacer gives you the possibility of having desired slope of the stock.

There are two stock drop spacers packed with the shotgun. One is 2.0mm and the other is 2.5mm. These two can be assembled together or separately.

**It is recommended to have your stock drop spacer(s) assembled by a qualified gunsmith.**

### **WARNING!**

**Before assembling the stock drop spacer(s), always make sure the shotgun is unloaded and the safety is engaged.**

#### **Assembly & disassembly of the stock drop spacer(s):**

- Unscrew (counter-clockwise) the butt plate screws, and remove the recoil pad. **(33)**
- Turn (counter-clockwise) the nut in the hole in which the stock connecting rod extends by means of a box spanner, and remove the stock connecting nut, spring washer and the washer. Then, remove the stock from the stock connection rod. **(34)**
- Assemble the stock drop spacer(s) and put the stock over the stock connection rod. **(35)**
- Assemble back the stock connecting nut, spring washer and the washer.
- Screw (clockwise) the butt plate screws to the end until the stock completely seats in its place.
- To disassemble the stock drop spacer(s), reverse the assembly process.



# CARE, CLEANING AND LUBRICATION

## **WARNING!**

**Before cleaning or lubricating the shotgun make sure it is unloaded and the safety “ON”.**

It is recommended to disassemble the shotgun to clean and to lubricate it when grease or dirt particles accumulate and combustion residues. To have the best resistance against corrosion, it is necessary to clean and lubricate the shotgun after each use, especially after use in wet and saline environment.

Materials and equipment necessary for cleaning and lubrication;

- Cleaning rod
  - Cotton bore patches
  - Brass bore brush
  - Powder solvent
  - Small soft brush
  - Good quality shotgun oil
- After use, to remove any powder and lead residue in the bore, scrub the barrel and chamber using the bore brush with powder solvent. Then do not forget to swab the bore and the chamber with shotgun oiled cotton patches to protect from rust and corrosion.
  - At the end of the hunting season or after a high number of shots (about 500 shots), disassemble the bolt assembly and clean it with a soft brush and shotgun oil. Then dry it carefully with a soft cloth and oil the parts lightly.
  - Take care of the trigger assembly as it is described for the bolt assembly.
  - Clean the outside of the magazine tube with a shotgun oiled soft cloth and then dry it with a soft cloth and oil the parts lightly.
  - Any powder on the firing wall, barrel, etc. can be cleaned with a brush and powder solvent.
  - All external surfaces should be wiped down with light coat of rust preventative.
  - Avoid using too much solvent for bore cleaning, since prolonged or excess contact can damage the finish of the wood. Make sure to wipe away all the excess solvent and lubricant.
  - After use, check the gas piston whether it slides freely inside the gas cylinder. Gas piston should be cleaned and very lightly oiled after each use. The two holes in the gas cylinder should be kept clear and open at all times to remain the shotgun functioning properly. Clean inside of the gas cylinder if necessary.
  - Check the rubber ‘O’ ring for cracks, splits, etc. and replace it with a new one if necessary.

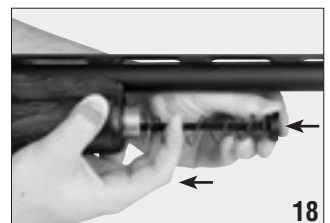
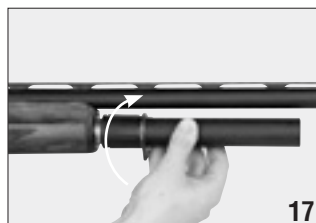
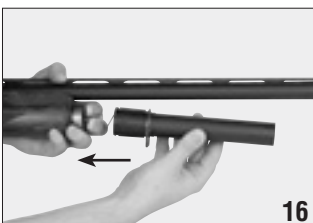
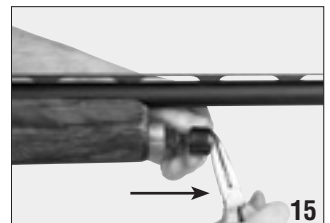
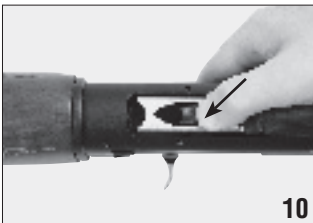
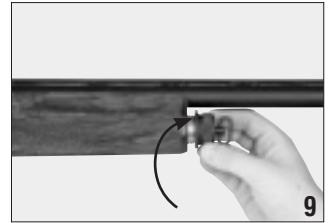
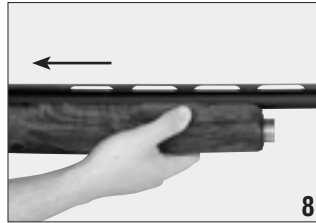
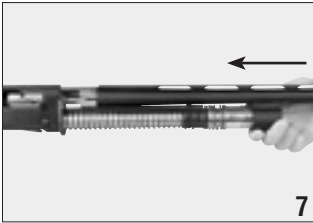
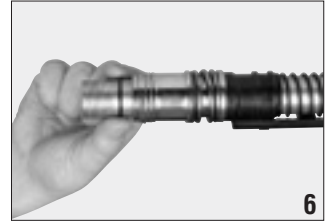
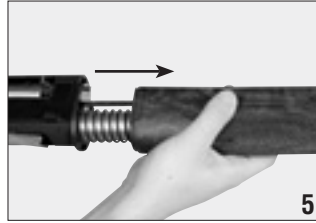
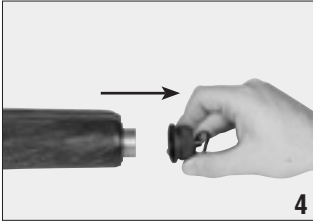
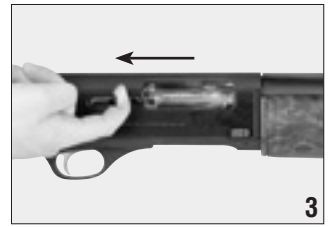

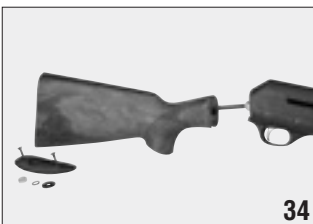
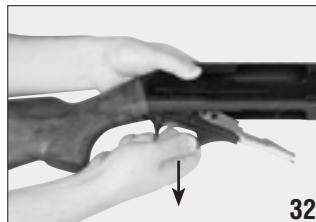
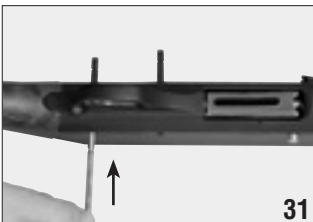
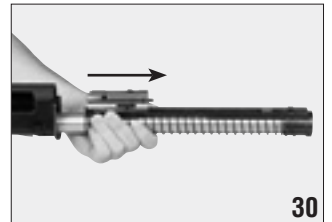
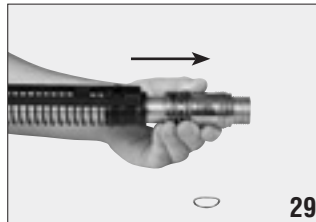
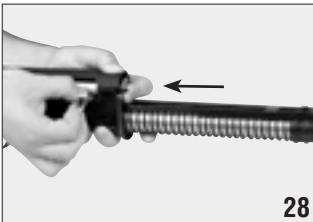
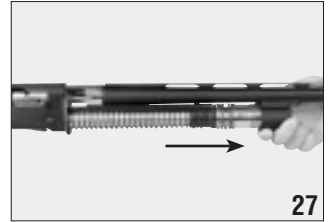
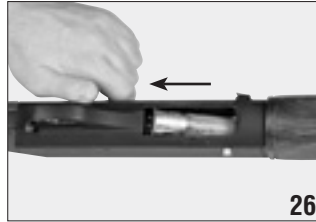
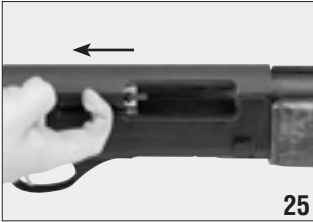
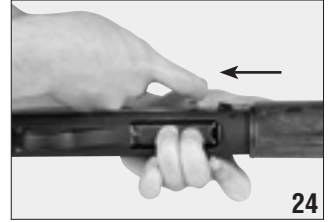
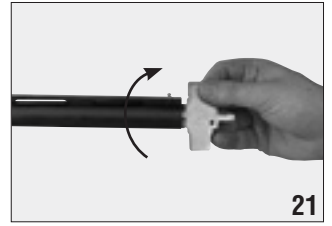
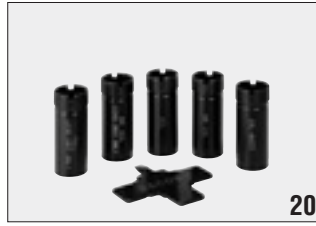
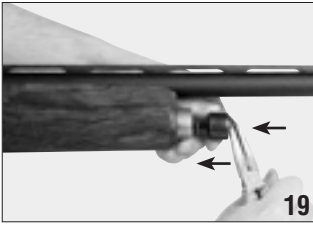



# HATSAN

## ARMS COMPANY

Izmir - Ankara Karayolu 26. km. No. 289 OSB Kemalpaşa 35170 Izmir - TURKEY  
Tel: +90 (232) 878 91 00 • Fax: +90 (232) 878 91 02

[www.hatsan.com.tr](http://www.hatsan.com.tr) [info@hatsan.com.tr](mailto:info@hatsan.com.tr)