



Safe ownership is your responsibility. Please thoroughly read and understand this manual before loading your firearm.

Keep firearms and ammunition away from children. Lock unloaded firearms and ammunition securely in separate locations.

This manual should always accompany your firearm and be transferred with it upon change of ownership. This is your responsibility and may protect you from future liability.

100 Springdale Road
Westfield, MA 01085

INSTRUCTION MANUAL

MODEL A17 MODEL A22 MAGNUM

IMPORTANT! DO NOT ATTEMPT TO LOAD AND SHOOT YOUR RIFLE UNTIL YOU HAVE THOROUGHLY READ THIS INSTRUCTION MANUAL AND ARE FULLY FAMILIAR WITH ITS CONTENTS

For more information, please visit our web site at www.savagearms.com

Download a QR Code reader app for your Smartphone
then snap this to open Savage Arms' homepage



WWW.SAVAGEARMS.COM

Congratulations on the purchase of your new firearm. You are now part of the Savage Arms, Inc. family of quality firearms. With reasonable care, your firearm should deliver years of reliable service and perform to our “definition of accuracy”.

⚠ WARNING

Risk of serious injury or death. Read and understand this manual completely before loading or using your new firearm. The Savage A17 and A22 MAGNUM incorporate features that you may not be familiar with.

- Use only new ammunition in good condition—inspect for damage before use.
- Never shoot a right-handed model left handed (or a left-handed model right handed). Doing so will put your face in the path of the forcefully-ejected case, as well as any hot gases, sparks or particles that may result from firing.
- Never disassemble your A17 or A22 MAGNUM beyond what’s recommended in this manual; particularly the bolt assembly, the recoil assembly and the trigger group. Doing so can disable critical safety features and result in injury.
- If you hear a weak or unusual sound or if the bullet does not exit the barrel when firing, STOP immediately.
- If anything ‘feels’ or sounds different - stop - and have a qualified gunsmith take a look.
- Never fire with the dust cover off or installed

incorrectly. Components inside are under pressure and could come off and cause injury during firing.

- Always wear eye and ear protection when shooting. Although rare, ricochets, case failures and gas escapement can occur and cause serious eye and ear injury without proper protection.

If you do not understand any part of this manual or have questions about your firearm, contact Savage Arms at 413-568-7001 between the hours of 9:00 AM and 4:00 PM Eastern Time. This manual should always accompany your firearm and be transferred with it upon change of ownership. If lost or misplaced, download a new manual at www.savagearms.com.

Performance

The A17 and A22 MAGNUM feature a patent-pending delayed blowback action, which prevents the bolt from opening prematurely. For optimal performance with your A17, use CCI A17 ammunition (designed specifically for the Savage A17) and CCI A22 MAGNUM ammunition (designed specifically for the Savage A22 MAGNUM). It is also important that on either the A17 or A22 MAGNUM: keep the bolt lightly lubricated at all times, ensure the magazine audibly snaps into position with the latch facing forward, pull back and release the bolt handle so it “snaps” forward to feed a cartridge, and hold the trigger back after each shot until the action fully cycles.

SECTION 1: SAFETY FIRST – IT’S YOUR RESPONSIBILITY..... 2

SECTION 2: TWO POSITION SAFETY 4

SECTION 3: AMMUNITION..... 5

SECTION 4: BASIC USE

- Loading..... 6
- Firing..... 7
- Unloading 7

SECTION 5: MAINTENANCE

- Timeframe 8
- Disassembly 9
- Cleaning 10
- Reassembly 11

SECTION 6: ACCUTRIGGER™

- Adjusting the AccuTrigger 13

SECTION 7: PARTS LIST AND DIAGRAM 14

SECTION 8: RINGS AND BASES FOR MOUNTING A SCOPE 17

SECTION 9: STATEMENT OF LIMITED WARRANTY..... 17

Although considerable time and effort was put into assuring the accuracy of the information contained herein, human errors do occur. If an error is found, please let us know. As a ‘customer driven’ company, we appreciate and encourage feedback.

SECTION 1 - SAFETY FIRST - IT'S YOUR RESPONSIBILITY

Above all – remember that a firearm is a mechanical device. It cannot think, it cannot act on its own – it only does what you make it do. A mechanical device has no way to know if your actions are safe or if they will result in injury or death – that's your part! It only takes one careless second to result in a tragedy that you will have to live with the rest of your life. Make no doubt about it, owning and/or using a firearm puts you in full control of its actions and their consequences!

Safety Alert Symbol And Signal Words

Safety alert symbol 

Indicates safety information in this manual that must be read and understood to prevent injury or death.

Signal Words:

DANGER

Indicates a hazardous situation which, if not avoided, **will** result in death or serious injury.

WARNING

Indicates a hazardous situation which, if not avoided, **could** result in death or serious injury.

CAUTION

Indicates a hazardous situation which, if not avoided, could result in minor or moderate injury.

NOTICE

Indicates a situation that could result in damage to the firearm or other property.

10 COMMANDMENTS OF SHOOTING SAFETY

The following excerpts are from SAAMI bulletin #081. The entire booklet can be obtained by contacting the NATIONAL SHOOTING SPORTS FOUNDATION.

FIREARMS SAFETY DEPENDS ON YOU!

From the time you pick up a firearm, you become part of a system over which you have complete control. You are the only part of the system that can make a gun safe – or unsafe.

You can help meet this responsibility by enrolling in hunter safety or shooter safety courses, if you have not already done so. You must constantly stress safety when handling firearms, especially to children and non-shooters. Develop safe shooting habits and remember, firearms safety is up to you. Make no mistake about it.

ALCOHOL, DRUGS AND GUNS DON'T MIX

1. ALWAYS KEEP THE MUZZLE POINTED IN A SAFE DIRECTION

This is the most basic safety rule. If everyone handled a firearm so carefully that the muzzle never pointed at something they didn't intend to shoot, there would be virtually no firearm accidents. It's as simple as that, and it's up to you.

Never point your gun at anything you do not intend to shoot. A safe direction means a direction in which a bullet cannot possibly strike anyone, taking into account possible ricochets and the fact

that bullets can penetrate walls and ceilings. Even when "dry firing" with an unloaded gun, you should never point the gun at an unintended target.

This is your responsibility, and only you can control it.

2. FIREARMS SHOULD BE UNLOADED WHEN NOT ACTUALLY IN USE

Firearms should be loaded only when you are in the field or on the target range or shooting area, ready to shoot. When not in use, firearms and ammunition should be secured in a safe place, separate from each other. It is your responsibility to prevent children and inexperienced adults from gaining access to firearms or ammunition. A loaded gun has no place in or near a vehicle or building.

Whenever you handle a firearm or hand it to someone, always open the action immediately, and visually check the chamber, receiver and magazine to be certain they do not contain any ammunition. Never assume a gun is unloaded – check for yourself! While in the field, there will be times when common sense and the basic rules of firearms safety will require you to unload your gun for maximum safety. When in doubt, unload your gun!

3. DON'T RELY ON YOUR GUN'S "SAFETY"

Treat every gun as though it can fire at any time, regardless of pressure on the TRIGGER. The "safety" on any gun is a mechanical device, which, like any such device, can become inoperable at

the worst possible time. The safety serves as a supplement to proper gun handling but cannot possibly serve as a substitute for common sense.

Never touch the trigger on a firearm until you actually intend to shoot.

Your firearm is a precision instrument. Regardless of the position of the safety, any bump strong enough to actuate the firing mechanism of a gun can cause it to fire. The only time you can be absolutely certain that a gun cannot fire is when the action is open and it is completely empty. You and the safe gun handling procedures you have learned are your gun's primary safeties.

4. BE SURE OF YOUR TARGET AND WHAT'S BEYOND IT

No one can call a bullet back. Don't shoot unless you know exactly what your bullet is going to strike. Be sure that your bullet will not injure anyone or anything beyond your target. You should keep in mind how far a bullet will travel if it misses your intended target or ricochets in another direction.

Be aware that even a .22 short bullet can travel over 1¼ miles and a high velocity cartridge, such as a 30-06, can project a bullet more than 3 miles. Shotgun pellets can travel 500 yards, and shotgun slugs have a range of over a half-mile.

5. USE CORRECT AMMUNITION

You must assume the serious responsibility of using only the correct ammunition for your firearm. Read and heed all warnings, including those that

appear in the gun's INSTRUCTION MANUAL and on the ammunition boxes. Using improper or incorrect ammunition can destroy a gun and cause serious personal injury. It only takes one cartridge of improper caliber or gauge to wreck your gun, and only a second to check each one as you load it. Be absolutely certain that the ammunition you are using matches the specifications that are contained within the gun's instruction manual and the manufacturer's markings on the firearm barrel.

Hand loaded or reloaded ammunition deviating from pressures generated by factory loads or from competent recommendations specified in reputable hand loading manuals can be dangerous, and can cause severe damage to guns and serious injury to the shooter.

Ammunition that has become very wet or has been submerged in water should be discarded in a safe manner. Do not spray oil or solvents on ammunition or place ammunition in excessively lubricated firearms.

Form the habit of examining every cartridge you put in your gun. Never use damaged, old or questionable ammunition – the money you save is not worth the risk of possible injury or a ruined gun.

Discharging firearms in poorly ventilated areas, cleaning firearms or handling ammunition may result in exposure to lead and other substances known to cause birth defects, reproductive harm and other serious physical injury. Have adequate ventilation at all times. Wash hands thoroughly after exposure.

6. IF YOUR GUN FAILS TO FIRE WHEN THE TRIGGER IS PULLED, HANDLE WITH CARE!

Occasionally, a loaded gun may not fire when the trigger is pulled. If this occurs, keep the muzzle pointed in a safe direction. Keep your face away from the breech. Then, carefully open the action, unload the firearm and dispose of the cartridge in a safe way.

Any time there is a cartridge in the chamber, your gun is loaded and ready to fire - even if you've tried to shoot and it did not go off. It could go off at any time, so you must always remember *RULE #1* and *WATCH THAT MUZZLE!*

7. ALWAYS WEAR EYE AND EAR PROTECTION WHEN SHOOTING

All shooters should wear protective shooting glasses and some form of hearing protectors while shooting. Exposure to shooting noise can damage hearing, and adequate vision protection is essential. Wearing eye protection when disassembling and cleaning any gun will also help prevent the possibility of springs, spring tensioned parts, solvents or other agents from contacting your eyes. No target shooter, plinker or hunter should ever be without them.

8. BE SURE THE BARREL IS CLEAR OF OBSTRUCTIONS BEFORE SHOOTING

Before you load your firearm, open the action and be certain that there is no cartridge in the chamber. Then glance through the barrel to be sure it is clear of any obstruction. Even a small bit of mud, snow, excess lubricating oil or grease in

the bore can cause dangerously increased pressure, causing the barrel to bulge or even burst when firing, which can cause injury to the shooter and bystanders. Make it a habit to clean the bore with a cleaning rod and patch to wipe away anti-rust compounds in the gun each time immediately before you shoot it. If the noise or recoil on firing seems weak or doesn't seem quite "right", cease firing immediately and be sure to check that no obstruction or projectile has become lodged in the barrel.

⚠ 9. DON'T ALTER OR MODIFY YOUR GUN, AND HAVE GUNS SERVICED REGULARLY

Firearms are complicated mechanisms, which are designed by experts to function properly in their original condition. Any alteration or change (other than adjusting the AccuTrigger) made to a firearm after manufacture can make the gun dangerous and will usually void any factory warranties. Do not jeopardize your safety or the safety of others by altering the trigger, safety or other mechanism of any firearm or allowing unqualified person's to repair or modify a gun.

Your gun is a mechanical device, which will not last forever and is subject to wear. As such, it requires periodic inspection, adjustment and service.

⚠ 10. LEARN THE MECHANISM AND HANDLING CHARACTERISTICS OF THE FIREARM YOU ARE USING

Not all firearms are the same. Consequently, never handle any firearm without first having thoroughly familiarized yourself with the particular

type of firearm you are using, the safe gun handling rules for loading, unloading, carrying and handling that firearm, and the rules of safe gun handling in general. Locate the firearm's mechanical safety device and get familiar with the feel and "on/off" positions.

You should always read and refer to the INSTRUCTION MANUAL you received with your gun, or if you have misplaced the manual, simply contact the manufacturer for a free copy.

Having a gun in your possession is a full-time job. You cannot guess; you cannot forget. You must know how to use, handle, and store your firearm safely. Do not use any firearm without having a complete understanding of its particular characteristics and safe use. There is no such thing as a foolproof gun.

SECTION 2 – TWO POSITION SAFETY

⚠ WARNING

Accidental discharge can cause serious injury or death. Always keep the safety on and your finger off the trigger until you have clearly identified your target, lined up your sights on the intended target and verified that the backstop is clear. Always store and transport your firearm: (1) with the magazine and chamber UNLOADED; (2) with the child safe lock properly installed; and (3) with the safety ON.

The SAFETY on your Model A17 and A22 MAGNUM has two positions:

1. **FULL SAFE** – If the action has been cocked (BOLT HANDLE pulled fully rearward and then allowed to snap forward), the SAFETY BUTTON can be pushed fully to the right covering the red band. If the action is uncocked, the SAFETY BUTTON can only be pushed half way to the right. As soon as the action is cocked, the SAFETY BUTTON will automatically move the rest of the way, covering the red band (see FIGURE 1).
- In the FULL SAFE position, the TRIGGER is blocked from releasing the hammer and striking the firing pin.
 - Always keep the SAFETY in the FULL SAFE position when there is live ammunition in either the MAGAZINE and/or chamber.



no red band

FIGURE 1

2. **SAFETY OFF/READY TO FIRE** – Push the SAFETY BUTTON fully to the left exposing the red band (see FIGURE 2).



red band

FIGURE 2

- In the SAFETY OFF – READY TO FIRE position, the hammer will strike the firing pin when cocked and the TRIGGER pulled.
- Only move the Safety to the SAFETY OFF – READY TO FIRE position when you have clearly identified your target, lined up your sights on the intended target and verified that the backstop is clear.

SECTION 3 – AMMUNITION

▲ WARNING

Using improper or damaged ammunition can cause serious injury or gun damage.

- Always inspect your ammunition before using it. Never use damaged, corroded/stained, old or questionable ammunition. The money you save is not worth the risk of possible injury or a damaged gun.
- If you hear a weak or unusual sound or if the bullet does not exit the barrel when firing, STOP immediately. Put the safety on, unload the firearm, disassemble (as detailed in SECTION 5) and check the barrel from the breech (not the muzzle) for any obstructions.
- Use only ammunition specifically designated as “.17 HMR” in the A17 and “22 WMR” in the A22 MAGNUM. These firearms are not compatible with any other caliber ammunition.
- Use only new ammunition manufactured to SAAMI specification. Any other ammunition can cause gun damage or personal injury, and will void the warranty.
- Routinely inspect the case head, rim and body of fired brass for any signs of unusual bulging or rupturing. If you find anything out of the ordinary, discontinue use immediately and call Savage Arms at 413-568-7001 (9:00 AM to 4:00 PM Eastern Time) or a qualified gunsmith.

For best performance, thoroughly clean and lightly lubricate the inside of the receiver, barrel, and chamber before loading with ammunition. Performance may vary based on brand/type of ammunition, individual characteristics of the firearm, and/or shooting conditions. Bullet specifications and trajectories are available directly from the ammunition manufacturer. For best results, use CCI A17 ammunition, which has been specifically optimized for use with your Savage A17 and CCI A22 MAGNUM ammunition (designed specifically for the Savage A22 MAGNUM).

SECTION 4 – BASIC USE

LOADING

▲ WARNING

Accidental discharge can cause serious injury or death. Never load or bring a loaded firearm into a car, house or structure. Always keep the safety on and your finger off the trigger until you have clearly identified your target, lined up your sights on the intended target and verified that the backstop is clear.

▲ WARNING

A barrel obstruction can cause excessive pressure upon firing and result in gun damage or personal injury to you or a bystander. Before loading and with the safety on, always inspect the barrel visually and with a cleaning rod for any sign of snow, mud, sticks, brush, leaves, debris, cleaning brushes, bullets or other obstructions. Never fire with the muzzle underwater or otherwise obstructed.

1. Ensure the SAFETY BUTTON is fully to the right to the FULL SAFE position (see FIGURE 1).
2. With one hand ready to catch the MAGAZINE, use the other hand to support the firearm and depress the latch at the front of the MAGAZINE, ejecting the MAGAZINE into your hand (see FIGURE 3).



FIGURE 3

3. With the muzzle pointed in a safe direction and your finger off the TRIGGER, slowly pull the BOLT HANDLE fully rearward.
4. While pushing upward on the BOLT LOCK, release the BOLT HANDLE. This will lock the BOLT open (see FIGURE 4).

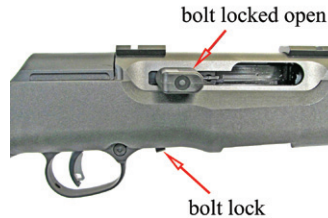

FIGURE 4

▲ CAUTION

The BOLT can forcefully slam shut unexpectedly. Keep your fingers out of the action at all times.

5. Look to be sure there is no cartridge in the chamber.
6. Load the correct cartridge type (see AMMUNITION section above) into the MAGAZINE by pressing downward on the cartridge rim and sliding under the MAGAZINE lips (see FIGURE 5).

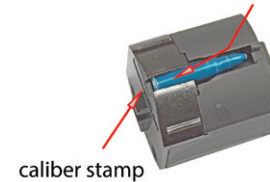

FIGURE 5
(.17 HMR shown)

▲ WARNING

Ensure the caliber stamp on the MAGAZINE (see FIGURE 5) and barrel are both .17 HMR. The ammunition you are using must also match exactly. Shooting incorrect ammunition can cause serious personal injury and gun damage.

7. With the latch facing forward, insert the MAGAZINE into the STOCK opening, pressing upward until the latch snaps into position and is fully engaged.
8. Grasping the BOLT HANDLE firmly, pull rearward (disengaging the BOLT LOCK).

9. Release the BOLT HANDLE allowing it to 'snap' forward.

▲ WARNING

Do not load a cartridge through the ejection port. Doing so increases the chance of an unintended discharge or out of battery firing due to a slam or pinch fire, which can result in personal injury or death. Always use the magazine for loading a cartridge into the chamber.

FIRING

▲ WARNING

Always wear eye and ear protection when shooting. Although rare, ricochets, case failures and gas escapement can occur and cause serious eye or ear injury without proper protection.

▲ WARNING

Do not shoot with a missing, broken or altered component (e.g., DUST COVER, ACTION SCREWS, EXTRACTOR). Doing so can affect the safe and proper function of your firearm, and result in personal injury and gun damage.

▲ WARNING

Always keep the safety on and your finger off the trigger until you have clearly identified your target, lined up your sights on the intended target and verified that the backstop is clear.

▲ WARNING

Never shoot a right-handed model left handed (or a left-handed model right handed). Doing so will put your face in the path of the forcefully-ejected

case, as well as any hot gases, sparks or particles that may result from firing.

▲ CAUTION

When firing, always keep your hand away from the magazine, ejection port and bolt handle. Moving parts, escaping gas or other debris can escape and cause burns or cuts during normal operation or in the unlikely event of a case failure.

1. Pull the firearm STOCK firmly into your shoulder. After confirming your target and a safe backstop, move the SAFETY fully to the left – SAFETY OFF – READY TO FIRE position.
2. Place your finger in the TRIGGER GUARD and when you are on target, squeeze the TRIGGER slowly. After each shot, the rifle will automatically cycle the BOLT HANDLE rearward and load a new cartridge into the chamber. If you experience difficulty with cycling, see Section 8 – MAINTENANCE.

▲ WARNING

When shooting, your finger must hold the trigger rearward until the action has cycled and the bolt has locked forward.

▲ WARNING

Never assume a MAGAZINE is empty, even if you hear a 'click' when the trigger is pulled.

▲ WARNING

If a cartridge fails to fire after pulling the trigger, point the muzzle in a safe direction, put the

SAFETY into the FULL SAFE position and wait 30 seconds. Follow the UNLOADING instructions to remove the cartridge.

UNLOADING

1. With the muzzle pointed in a safe direction, your finger off the trigger and the SAFETY on, depress the latch at the front of the MAGAZINE and remove it from the firearm.
2. Pull back on the BOLT HANDLE while pushing upward on the BOLT LOCK. Release the BOLT HANDLE. This will lock the BOLT open.
3. Look in the chamber to ensure it is empty. Do not assume!
4. Carefully look down into the cartridge opening of the MAGAZINE to be sure it is empty. A colored stripe will be visible indicating that it is cartridge slot #1.

SECTION 5 – MAINTENANCE

▲ WARNING

Ensure the gun is unloaded and the safety is on before disassembling or cleaning in any way. Never attempt to disassemble, clean, or oil a loaded firearm. Look and feel! Be sure the chamber and magazine are completely empty – do not assume!

▲ WARNING

Do not disassemble beyond what is recommended below. Doing so can damage or disable critical safety features or interfere with the safe operation of your firearm and cause personal injury or gun damage.

▲ WARNING

Bolt assemblies and other parts are specifically matched to your firearm. Interchanging parts from other firearms can cause serious injury or gun damage. To avoid mixing components, disassemble only one firearm at a time and check each time to ensure that the serial number on the BOLT ASSEMBLY (see FIGURE 6) matches the last four digits of the serial number on the RECEIVER.



FIGURE 6

TIMEFRAME

Rimfire cartridges can leave unburnt powder, soot, bullet lube, and other contaminants (to name a few) in the receiver, chamber, and barrel, causing unreliable function. In addition, like any mechanical device your gun will not last forever and is subject to wear. When something does not sound, feel, or look right, seek the advice of a professional gunsmith immediately. Never take a chance. As with any precision tuned mechanical device, periodic inspection/maintenance is required – and your responsibility.

It is difficult to establish a time period or number of rounds as the basis for when a firearm should be examined, cleaned, and thoroughly inspected. Different shooting conditions, weather patterns, and types of ammunition, to list a few, all play a significant role in answering the questions 'when' and 'how often'. As a general rule, 'more often' is much safer than 'not enough'. We recommend performing these basic procedures WITH AN UNLOADED FIREARM before every shooting session and cleaning after every use.

- Locking the BOLT HANDLE open, shine a light into the ejection port and look down the barrel to be sure it is clear of any obstructions. There should be no signs of damage (nicks, scratches, etc.), rust, or pitting.
- Function the BOLT HANDLE making sure that it cycles the BOLT without binding.
- Check the outer surface of the barrel, running your fingers gently down the length, feeling for any bulges or signs of damage.
- While the action is open, inspect the inside of the receiver and bolt face for signs of damage, excessive wear, excessive firing residue, or missing components.
- Carefully examine the STOCK and studs that secure the carrying strap.
- Be sure the DUST COVER is in place and the RECOIL ASSEMBLY properly seated in its place.
- Check the scope rings and bases for tightness.
- Be sure that action screws are tight prior to each shooting session.

WHO SHOULD DO THE CHECKING: As the owner – or user – it is your primary responsibility to assure the firearm is safe prior to using it. Although we know its condition when it leaves the factory, we have no control or insight as to what has or has not been done once it leaves our hands.

After reading and understanding this INSTRUCTION MANUAL – and prior to loading with live ammunition - you should be very familiar and capable of handling the items noted above. In depth mechanical issues or questions as well as periodic examinations should be referred to a qualified gunsmith or Savage Arms Service Department.

Mechanical devices will by the nature of their design, wear and as such may require very specific adjustments. Placed in the wrong hands and improperly done, you may be responsible for an injury or even death of the shooter or bystander.

DISASSEMBLY

⚠ CAUTION

Parts are under tension. Keep your fingers and eyes away from springs and moving parts and always wear eye protection during disassembly and cleaning.

NOTE Be sure the SAFETY stays in the FULL SAFE position to prevent the hammer from snapping forward during the disassembly/assembly process.

1. After confirming the firearm is unloaded (as detailed in SECTION 4) and the safety is on, CLOSE THE BOLT.

⚠ CAUTION

Attempting to disassemble with the bolt open will put extreme pressure on the recoil assembly, which could cause injury.

2. Insert a small punch through the opening of the DUST COVER, gently pushing the RECOIL ASSEMBLY forward and upward (see FIGURE 7).



FIGURE 7

3. Carefully lift the DUST COVER from the receiver (see FIGURE 8).

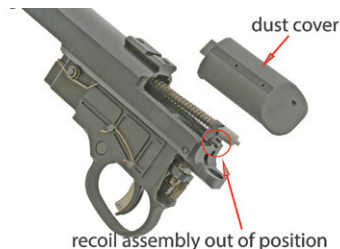

FIGURE 8

4. Carefully remove the RECOIL ASSEMBLY (see FIGURE 9).

⚠ WARNING

Parts will be under tension. Release spring slowly and keep away from your eyes.



FIGURE 9

With the RECOIL ASSEMBLY removed, the BOLT HANDLE is no longer retained, allowing it and the BOLT assembly to fall out if the action is tilted.

⚠ WARNING

Damage to or alteration of the RECOIL ASSEMBLY can affect the safe operation of your firearm, and result in injury and gun damage. Do not attempt to disassemble the RECOIL ASSEMBLY. Inspect the RECOIL ASSEMBLY for damage. If the RECOIL SPRING, RETENTION CLIP or GUIDE ROD appear damaged, bent or unsecured, DO NOT USE. Contact Savage Arms Immediately.

5. Remove the rear STOCK ASSEMBLY SCREW using a 5/32 Allen wrench (see FIGURE 10).



FIGURE 10

- Remove the front STOCK ASSEMBLY SCREW using a 5/32 Allen wrench (see FIGURE 11).

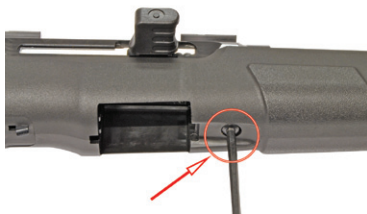

FIGURE 11

- Centrally position the SAFETY so that it does not interfere with removing the STOCK.
- Remove the STOCK. The TRIGGER HOUSING RETAINING PIN will fall out if the action is tilted sideways.
- Slide the TRIGGER HOUSING RETAINING PIN from the receiver (see FIGURE 12).



FIGURE 12

- Remove the TRIGGER HOUSING ASSEMBLY by sliding it forward then tipping the rear downward (see FIGURE 13).



FIGURE 13

- Remove the BOLT HANDLE and then BOLT ASSEMBLY by sliding it back through the receiver and upward (see FIGURE 14).

▲ WARNING

Damage to or alteration of the TRIGGER ASSEMBLY can affect the safe operation of your firearm, and result in injury and gun damage. Do not attempt to disassemble the TRIGGER ASSEMBLY. Inspect the TRIGGER ASSEMBLY

for damage. If any part appears damaged or unsecured, DO NOT USE. Contact Savage Arms immediately.

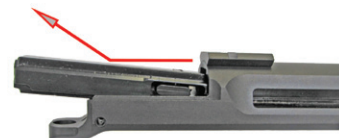

FIGURE 14

▲ WARNING

Damage to or alteration of the BOLT ASSEMBLY can affect the safe operation of your firearm, and result in injury and gun damage. Do not attempt to disassemble the BOLT ASSEMBLY.

▲ WARNING

Do not disable your A17 or A22 MAGNUM beyond this point. Disassembling anything (such as but not limited to: bolt assembly, trigger assembly, recoil assembly, etc.) other than what you have been instructed to do may cause damage to the firearm and/or injury to the shooter or bystander.

CLEANING

▲ WARNING

Failure to properly maintain your firearm may lead to damage and/or serious injury to the shooter or bystander.

1. Prepare an area for cleaning the firearm with a suitable surface, adequate ventilation, correct caliber cleaning rod, brush, patches, powder solvent, and lubricant. Be sure to read and understand all of the cautions and warnings on all solvents and chemicals prior to use. Follow the manufacturer's instructions for best cleaning results.
2. Disassemble as described in the applicable section above.
3. Lay the firearm horizontally.
4. Using a small amount of powder solvent on the brush, push the cleaning rod through the barrel several times. Always start from the chamber end and push the cleaning rod from the bore out the muzzle end.
5. Unscrew the brush from the cleaning rod and replace it with a patch tip.
6. Push a new patch through the bore starting from the chamber end and out the muzzle.
7. Repeat the prior step (# 6) several times.
8. Push a new patch saturated with gun lubricant through the bore.
9. Push a new dry patch through the bore to remove the excess lubricant.
10. Shine a light into the ejection port and look down the barrel to ensure it is clear from any obstructions or damage.

⚠ WARNING

If the barrel or chamber show signs of nicks, scratches, rust, pitting or other damage, **DO NOT USE**. Damage can result in high pressure and cause personal injury.

11. Carefully wipe all BOLT components, removing any contaminants and apply a VERY LIGHT coat of gun lubricant. A very thin film is sufficient protection – do not over lubricate!!!
11. Clean and lightly lubricate all interior metal surfaces.
12. Reassemble per the applicable section above.
13. When done, always verify that the two position SAFETY is operational as explained in SECTION 2.

⚠ WARNING

Check the bore carefully by looking through the breech end (not the muzzle) to be sure there are no obstructions (i.e., pieces of cleaning patch, a cleaning brush, cleaning rod). A barrel obstruction can cause excessive pressure upon firing and result in gun damage or personal injury to you or a bystander.

REASSEMBLY

1. Insert the BOLT ASSEMBLY into the back of the RECEIVER, being sure to orient it properly (see FIGURE 15).



FIGURE 15

2. Prior to installing the TRIGGER HOUSING ASSEMBLY, verify that the MAGAZINE EJECTOR SPRING is positioned properly (see FIGURE 16) and the SAFETY is still in the FULL SAFE position.

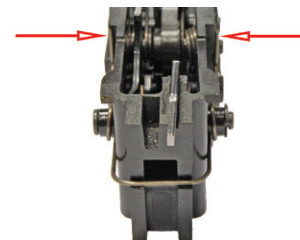

FIGURE 16

⚠ CAUTION

Watch your fingers – parts are under tension! Moving the SAFETY off of FULL SAFE may allow the hammer to snap forward.

3. Insert the TRIGGER HOUSING ASSEMBLY into the receiver, aligning the tabs on the receiver to the flats on the TRIGGER HOUSING (see FIGURE 17).



FIGURE 17

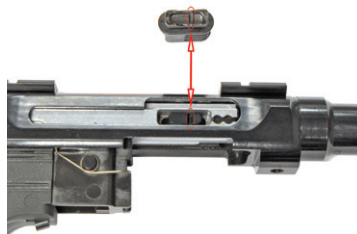

FIGURE 18



FIGURE 19

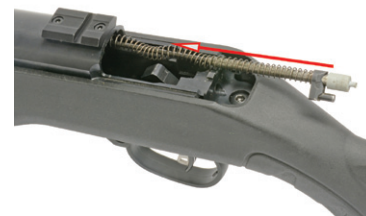

FIGURE 20

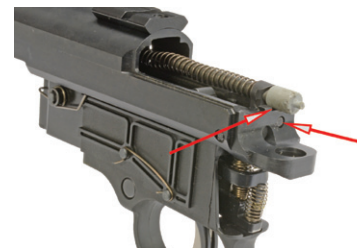

FIGURE 21

4. Once in place, slide the entire TRIGGER HOUSING ASSEMBLY rearward until rests firmly against the rear of the receiver.
5. Insert the TRIGGER HOUSING RETAINING PIN (opposite of FIGURE 12). The TRIGGER HOUSING PIN will fall out if the action is tilted sideways.
6. Orient the BOLT HANDLE as shown in FIGURE 18 and then insert it into the BOLT ASSEMBLY (see FIGURE 19).

The bolt handle will fall out if the action is tilted sideways.

7. Slide the BOLT rearward so as to see the hole for the RECOIL ASSEMBLY.
8. Insert the RECOIL ASSEMBLY into the back of the BOLT (see FIGURE 20).

9. Slightly compress the back of the RECOIL ASSEMBLY to secure it in the receiver (see FIGURE 21).

⚠ WARNING

The recoil assembly must be positioned correctly in order to retain the DUST COVER while firing. If incorrectly positioned, the DUST COVER may come loose during firing and injure the shooter.

10. Place the action back into the STOCK, push firmly rearward to ensure contact in the recoil lug area, and secure the front STOCK ASSEMBLY SCREW first to 40 inch pounds.

11. Install the rear STOCK ASSEMBLY SCREW to 40 inch pounds.
12. Carefully position the DUST COVER so that the front tab is inside the receiver and the sides are straddling the receiver (see FIGURE 22).



FIGURE 22

13. Slide the DUST COVER forward and down until it locks into position (see FIGURE 23).



FIGURE 23

⚠ WARNING

Ensure the DUST COVER is seated properly and locked into position (sides flush with the receiver and grey 'button' fully engaged in the opening). An unsecured DUST COVER may come off during firing and injure the shooter.

14. Cycle the action and engage the SAFETY several times to assure that it is functioning properly prior to loading. If the action does not cycle properly or the bolt binds, remove the DUST COVER and review the steps above. If there continues to be a problem, call Savage Arms Service Department for assistance (413-568-7001 between 9:00 AM and 4:00 PM Eastern Time). Never take a chance with something that you are unsure of ... always ask a professional.

SECTION 6 – ACCUTRIGGER

⚠ WARNING

An accidental discharge can cause serious injury or death. Before adjusting the AccuTrigger, ensure the safety is on, the magazine removed, there is no live ammunition in the chamber and the BOLT is locked open.

On the Model A17 and A22 MAGNUM, the STOCK does not have to be removed to adjust the AccuTrigger.

1. Insert the AccuTrigger supplied TOOL through the small hole in the TRIGGER GUARD (see FIGURE 24) and rotate gently until it engages the TRIGGER RETURN SPRING.



FIGURE 24

2. Turn the AccuTrigger supplied TOOL clockwise (firearm upside down on a flat surface with the barrel pointed away from you) to increase the trigger pull.
3. Turn the AccuTrigger supplied TOOL counterclockwise (firearm upside down on a

flat surface with the barrel pointed away from you) to decrease the trigger pull.

Never force the spring past its limits. When you feel the tension begin to increase, the spring has reached the end of its travel.

Excessive jarring or pulling the TRIGGER without depressing the AccuRelease (see FIGURE 24) may cause the sear to move. As designed, the AccuRelease will prevent accidental discharge when maintained and serviced regularly.

SECTION 7 – PARTS LIST AND DIAGRAM

As a 'customer driven' company, some parts may now be ordered directly from our web site (WWW.SAVAGEARMS.COM) within the continental United States, twenty four hours a day. All you will need is the serial number and credit card. For accessing our part finder via your Smartphone, please use the QR Code below. Should you not have access to our web site, parts can be ordered directly from Savage Arms (413-568-7001 between the hours of 9:00 AM and 4:00 PM Eastern Time). There is a minimum order and please allow 2 weeks for delivery. Only the parts indicated may be purchased by an individual. All other parts/subassemblies are either 'factory fit' or available to qualified gunsmiths only.

Please be advised that some parts may require fitting. Savage Arms bears no responsibility for the function or performance of any firearm that has been repaired or modified by other than Savage Arms Service Department. As such, Savage Arms accepts no responsibility/liability for any direct and/or consequential damage and/or injury resulting from the use of a firearm repaired or modified by other than the Savage Arms Service Department.

QR Code for your Smartphone for purchasing parts directly from our website – no calls – no waiting – 24 hours a day.



STORE.SAVAGEARMS.COM/PARTFINDER

Some parts are under tension – watch your fingers and always wear eye protection.

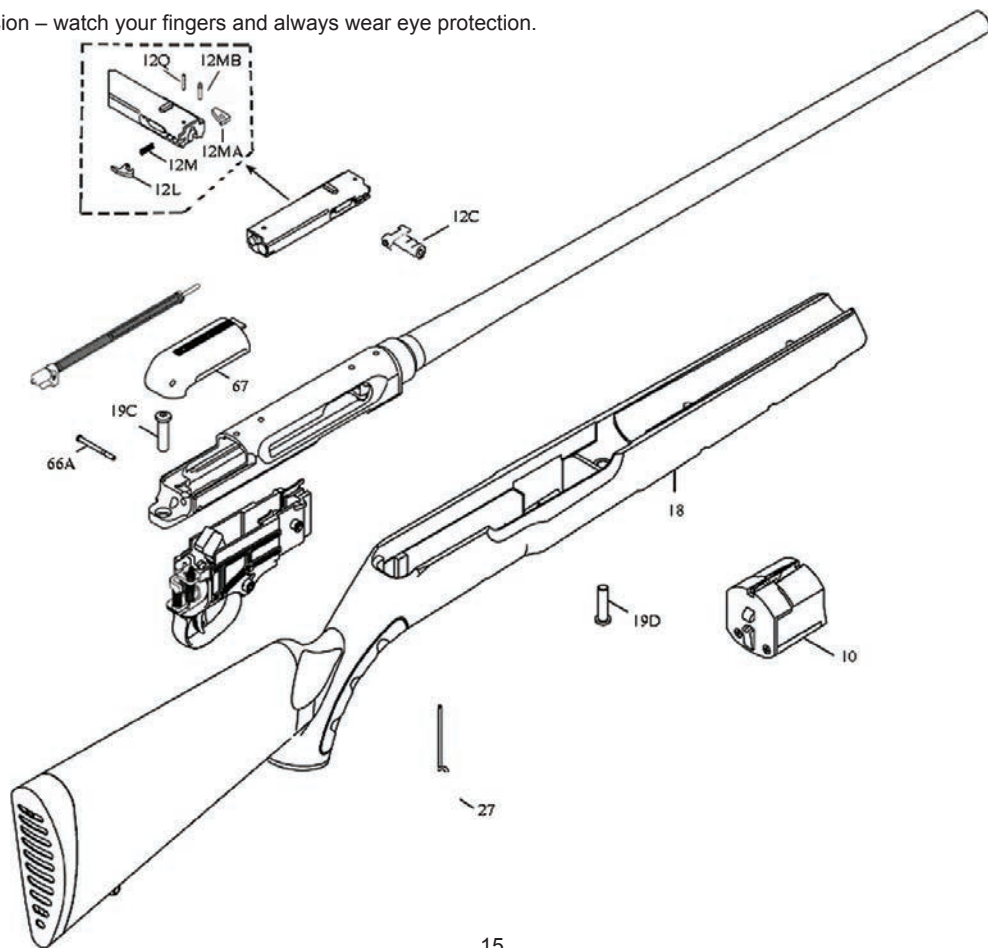

<u>Item #</u>	<u>Description</u>
10	magazine box assembly
12C	bolt handle
12L	extractor
12M	extractor spring
12MA	stabilizer

<u>Item #</u>	<u>Description</u>
12MB	stabilizer retaining pin
12Q	extractor retaining pin
18	stock assembly
19C	rear action screw
19D	front action screw

<u>Item #</u>	<u>Description</u>
27	tension adjustment tool
66A	fire control retaining pin
67	dust cover

SECTION 8 – RINGS AND BASES FOR MOUNTING A SCOPE

The model A17 and A22 MAGNUM dust cover has two holes that are not intended for mounting a scope (see FIGURE 25).



FIGURE 25

The following are some companies that manufacture RINGS that may be used with this style base or their own design and should be contacted for specific part numbers and item descriptions.

WEAVER MOUNTS
www.weaver-mounts.com

KWIK-SITE
www.kwiksitecorp.com

B-SQUARE
www.b-square.com

LEATHERWOOD /HI-LUX OPTICS
www.leatherwoodoptics.com

EVOLUTION GUN WORKS (EGW)
www.egguns.com

BURRIS
www.burrisoptics.com

MILLETT
www.millettsights.com

LEUPOLD
www.leupold.com

WARNE SCOPE MOUNTS
www.warnescopemounts.com

SECTION 9 – STATEMENT OF LIMITED WARRANTY

For your convenience, registration may now be completed directly from our web site (WWW.SAVAGEARMS.COM) twenty four hours a day. Should you not have access to our web site, please complete the WARRANTY REGISTRATION CARD and return it to Savage Arms, Inc. within ten (10) days from the date of purchase.

WHO IS COVERED?

- The original owner (with proof of purchase).

WHAT IS COVERED?

- Any defect in materials or workmanship (performed by Savage Arms) encountered during normal use.

HOW LONG IS THE WARRANTY PERIOD?

- One (1) year from the date of purchase.

WHAT IS NOT COVERED?

PERSONAL INJURY, PROPERTY DAMAGE, AND/OR DAMAGE TO THE FIREARM CAUSED BY:

- Improper maintenance or failure to provide proper care and maintenance in accordance with this manual.
- Alterations/modifications performed without the written authorization of Savage Arms Service Department.
- Normal wear; tear; and/or corrosion.
- Accidental discharge, careless handling, and/or misuse.

- Barrel obstructions.
- Use of incorrect ammunition or ammunition other than new/or not loaded to SAAMI specification.

EXCLUSIONS AND LIMITATIONS:

ANY WARRANTIES IMPLIED BY LAW SHALL IN NO EVENT EXTEND BEYOND THE DURATION OF THIS EXPRESS WARRANTY. Some States do not allow limitations on how long an implied warranty lasts, so the above limitation may not apply to you. REPAIR OR REPLACEMENT AS PROVIDED HEREIN IS YOUR EXCLUSIVE REMEDY FOR ANY DEFECTIVE PRODUCT. IN NO EVENT SHALL WE BE LIABLE FOR ANY SPECIAL, INCIDENTAL OR CONSEQUENTIAL DAMAGES OF ANY KIND ARISING OUT OF THE PURCHASE OR USE OF THIS PRODUCT, WHETHER BASED UPON CONTRACT, TORT, STATUTE OR OTHERWISE. Some states do not allow the exclusion or limitation of incidental or consequential damages, so the above limitation or exclusion may not apply to you. This warranty gives you specific legal rights, and you may also have other rights which vary from State to State.

RETURNING A FIREARM:

For WARRANTY claims, proof of purchase must accompany the firearm.

It is a violation of Federal Law to ship a firearm with live ammunition either in the MAGAZINE, chamber, or placed in the box. For the safety of all involved, please be sure there is no ammunition in either the chamber, MAGAZINE, or box.

Savage Arms, Inc, is not responsible for the loss or damage to any accessories shipped with the firearm.

If there is a question whether the firearm should be returned or parts could be purchased, please call 413-568-7001 between 9:00 AM and 4:00 PM Eastern Time and ask for the Service/Warranty Department.

All firearms are to be sent to Savage Arms at the owner's expense. Warranty repairs will be returned to the owner at Savage Arms' expense.

1. Pack the firearm in its original box if possible. If a similar suitable box is used, care should be taken to protect the barrel/muzzle from breaking through. Always pack with the assumption that the firearm will undergo rough handling during transit to Savage Arms.
2. Enclose a brief note including:
 - name, address and phone number of the sender
 - serial number of the firearm
 - description of the problem you are having
 - bullet weight, bullet type, and manufacturer of the ammunition you are using
 - any other information which you feel may be helpful.
3. Return to:
Savage Arms
100 Springdale Road
Westfield, MA 01085
Attn: Service Department

4. If there will be a charge involved for the repair, a quote will be sent within fourteen (14) working days.
 - If there is no response from the quote within thirty (30) days, the firearm will be returned COD (\$20.00 Shipping/Handling).

Firearms will be repaired typically 3 weeks after receipt of payment in the order they were received.



**You're proud to
shoot a Savage—
so show it!**

Choose from a wide selection of Savage t-shirts, hats and other great apparel and gear at store.savagearms.com.

Don't miss out—check back often for the latest designs.

Receive **10% OFF**
your first order!

Code will be emailed to you after you complete your online warranty registration.

www.store.savagearms.com



For more than a century, Savage Arms has carefully crafted the world's most accurate, consistent and reliable firearms. We're proud to stand behind our products with a 1-year warranty, and we're willing to do whatever it takes to ensure your Savage performs as it should.

To take full advantage of this warranty, please register your firearm at www.savagearms.com/warranty.

For new product purchases, please complete the online warranty registration within 10 days from the date of purchase.

Statement of Limited Warranty

Who is covered?

The original owner (with proof of purchase).

How long is the warranty period?

One (1) year from the date of purchase.

What is covered?

Any defect in materials or workmanship (performed by Savage Arms) encountered during normal use.

What is NOT covered?

Personal injury, property damage, and/or damage to the firearm caused by:

- Improper maintenance or negligence to provide proper care and maintenance.
- Alterations/modifications performed without the written authorization of the Savage Arms Service Department.
- Normal wear, tear and/or corrosion.
- Accidental discharge, careless handling and/or misuse.
- Barrel obstructions.

Exclusions and Limitations

This warranty and the remedies set forth herein are exclusive and take the place of all other expressed or implied WARRANTIES (including any implied warranty of merchantability or fitness for any particular purpose which are disclaimed). No other representations or claims of any nature shall be binding on or obligate Savage Arms. Savage Arms excludes any incidental and consequential damages under this warranty. Some states do not allow exclusions or limitations on how long an implied warranty lasts, so the above limitations may not apply to you.

This warranty gives you specific legal rights. You may have other rights, which will vary from state to state.



WARNING

Firearms must be handled responsibly and securely stored to prevent access by children and other unauthorized users. California has strict laws pertaining to firearms, and you may be fined or imprisoned if you fail to comply with them. Visit the website of the California Attorney General at <https://oag.ca.gov/firearms> for information on firearm laws applicable to you and how you can comply.

Prevent child access by always keeping guns locked away and unloaded when not in use. If you keep a loaded firearm where a child obtains and improperly uses it, you may be fined or sent to prison.

If you or someone you know is contemplating suicide, please call the national suicide prevention lifeline at 1-800-273-TALK (8255).



WARNING

This product can expose you to chemicals including lead, which is known to the State of California to cause cancer and reproductive harm. For more information go to www.P65Warnings.ca.gov



ADVERTENCIA

Las armas de fuego deben ser manejadas de manera responsable y almacenada de manera segura para evitar el acceso de niños y otros usuarios no autorizados. California tiene leyes estrictas relativas a las armas de fuego, y puede ser multado o encarcelado si no cumple con ellas. Visite el sitio web del Procurador General de California en <https://oag.ca.gov/firearms> para obtener información sobre las leyes de armas de fuego aplicables a usted y cómo puede cumplir.

Evite el acceso de los niños manteniendo siempre las armas cerradas y descargadas cuando no estén en uso. Si mantiene un arma de fuego cargada donde un niño la obtiene y la usa incorrectamente, puede ser multado o enviado a prisión.

Si usted o alguien que conoce está contemplando el suicidio, llame a la línea de vida nacional de prevención del suicidio al 1-800-273-TALK (8255).



ADVERTENCIA

Este producto puede exponerle a sustancias químicas que incluyen el plomo, que el estado de California reconoce como causante de cáncer y daños al sistema reproductivo. Para más información, visite www.P65Warnings.ca.gov



AVERTISSEMENT

Les armes à feu doivent être manipulées de manière responsable et stockées en toute sécurité pour empêcher les enfants et les autres utilisateurs non autorisés d'y accéder. La Californie a des lois strictes concernant les armes à feu et vous pouvez être condamné à une amende ou à une peine d'emprisonnement si vous ne vous y conformez pas. Visitez le site Web du procureur général de Californie à <https://oag.ca.gov/firearms> pour obtenir des informations sur les lois sur les armes à feu qui vous concernent et comment vous pouvez vous y conformer.

Empêchez l'accès des enfants en gardant toujours les pistolets sous clé et déchargés lorsqu'ils ne sont pas utilisés. Si vous gardez une arme à feu chargée là où un enfant l'obtient et l'utilise de manière inappropriée, vous pourriez être condamné à une amende ou à une peine de prison.

Si vous ou quelqu'un que vous connaissez envisagez le suicide, veuillez appeler la ligne de vie nationale pour la prévention du suicide au 1-800-273-TALK (8255).



AVERTISSEMENT

Ce produit peut exposer l'utilisateur à des produits chimiques, comme le plomb, que l'État de Californie reconnaît comme étant cancérigène et nocif pour la reproduction. Pour plus d'information, consultez le www.P65Warnings.ca.gov



100 Springdale Road, Westfield, MA 01085

www.savagearms.com (800) 370-0708 (413) 568-7001

111406 (08/20) Rev. 1